

CliniLever® CP-BS Lead Safe™ Hospital Wall Mixing Set Type 51 Swivel 150 C/D

PRODUCT CODE:

- 102.21.21.00

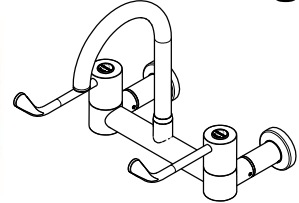

SPECIFICATIONS

- The CliniLever® product range is primarily used for hand washing applications in medical facilities, hospitals, aged care facilities, schools, and in-home care.
- CliniLever® products provide state of the art features to comply with the latest healthcare guidelines.
- The dual levers for on/off, hot, and cold temperature have a straightforward operation which simplifies hand washing.
- All CliniLever® products provide laminar flow (not aerated).
- Our highly sought-after lever handle design is easily operated with elbows or wrists to avoid hand contact.
- The main body is made of solid dezincification resistant (DR) brass rod, with a DR brass gooseneck outlet.
- Quick action SBA's includes brass ceramic cartridge component, with red and blue indicator button on 150mm lever action handles.
- Lead Safe™ brass construction*

IMPORTANT: All CliniLever® healthcare taps are tested in accordance with AS/NZS 3718 and leave our premises in good working order.

*As 'lead free' is not currently defined by law in Australia and New Zealand, we have based our definition of Lead Safe™ on the requirements of Sec 1417 of the USA's Safe Drinking Water Act (SDWA) and the relevant US standards NSF61 / NSF372. The SDWA defines 'lead free' as "not more than a weighted average of 0.25% lead when used with respect to the wetted surface of pipes, pipe fittings, plumbing fittings and fixtures".

WARNINGS: Special attentions to be paid on notes, photos, images, or drawings of assembly steps marked with the warning symbol.



TECHNICAL DATA

Inlet	1/2" BSP – Female	
Outlet	Laminar Flow	
Headwork	Ceramic Disc	
Working Pressure Range (kPa)	Min	50
	Max	500
Working Temperature Range (°C)	Min	5
	Max	65
Nominal Flow Rate (LPM)	4.9	
Finish	Chrome	

NOTE: Galvin Engineering continually strive to improve their products. Specifications may change without notice.

TOOLS REQUIRED

- Spanner
- Hex key
- Screwdriver

PRE-INSTALLATION - MOUNTING DETAILS

Note: Before installation, all lines must be flushed. We recommend that a line strainer be installed prior to taps to eliminate any foreign material.

Hole Centres

- Hole centres must be at 215±0.5mm
- This is critical to ensure easy installation
- Wall spuds must be ½ BSP MI and protrude from the finished wall by no more than 15mm

Note: In some situations, a male thread connection on the tap may be more suited. If so, please contact us on 1300 514 074

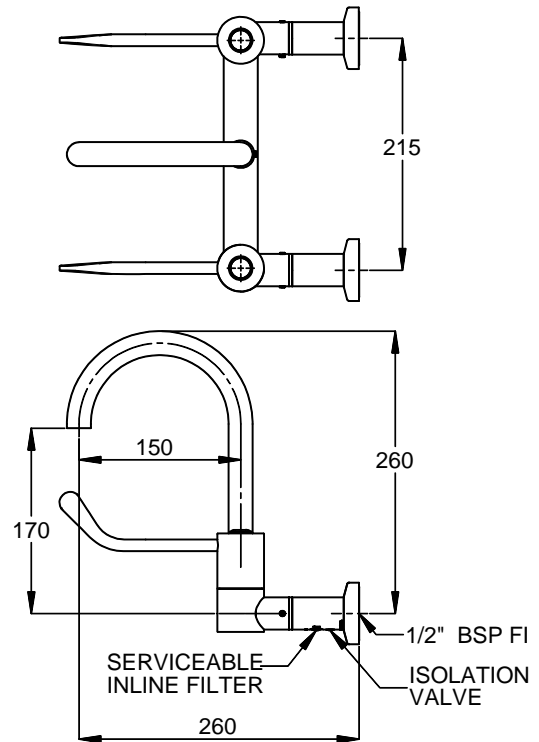
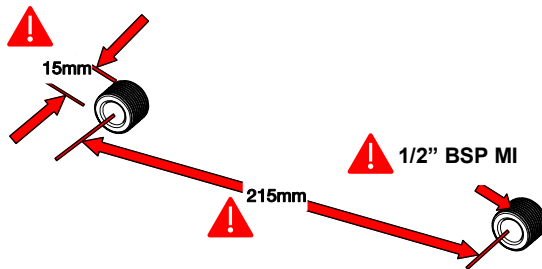

INSTALLATION

INSTALLATION COMPLIANCE: Galvin Engineering products must be installed in accordance with these installation instructions and in accordance with AS/NZS 3500, the PCA and your local regulatory requirements. Water and/or electrical supply conditions must also comply to the applicable national and/or state standards. Failing to comply with these provisions shall void the product warranty and may affect the performance of the product.

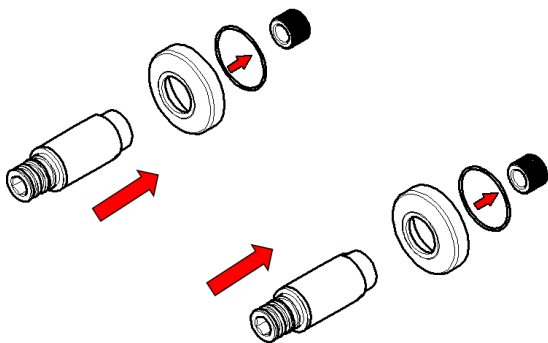

1. Fit wall flange

- Take the wall flanges out of the packaging and fit to wall.
- Ensure o-rings are secure in the rear of the wall flange and slide over the maintenance tail.

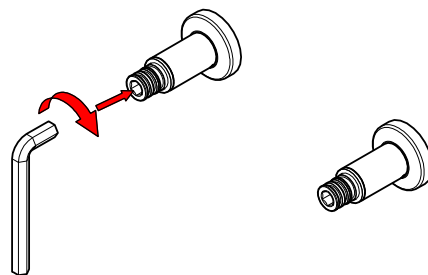

2. Fit maintenance tail

- Fit the maintenance tail (with wall flange) to the wall spud and fasten with the supplied 12mm Allen key. We recommend using thread tape or equivalent to ensure the connection does not leak.

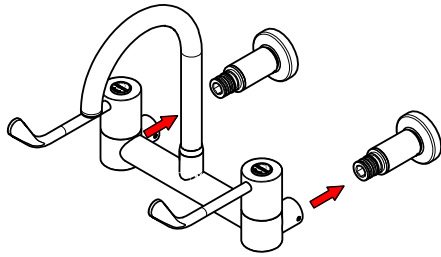

3. Fit CliniLever® body

- Check maintenance tails to ensure o-rings are fitted correctly and are in good condition.
- Fit the CliniLever® body onto the maintenance tails until it sits flush against them, taking care not to damage the o-rings.

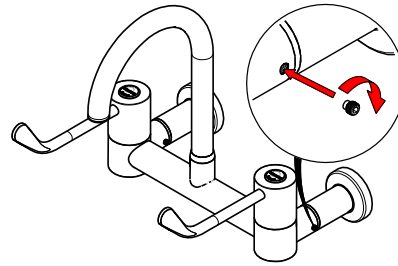

4. Fit grub screws and test

- Ensure the CliniLever® body is pushed firmly against the maintenance tail and then secure in place with the supplied grub screws.
ENSURE ALL FOUR (4) GRUB SCREWS ARE FITTED WITH SUPPLIED ALLEN KEY. If grub screws are missing, contact us on 1300 514 074.
- Once grub screws are secure, ensure the isolating valve is open and turn on mains water. Open the lever handles and ensure there is flow from both hot and cold inlets. Inspect the tap and check for any leaks.

TROUBLESHOOTING

PROBLEM	CAUSE	RECTIFICATION
Taps are dripping water	Ceramic discs are worn or damaged	Remove and inspect SBA. Remove debris and/or replace SBA if damaged.
	Tap seat is damaged	Refurbish tap seat using a reseating tool.
Water is not flowing from tap	Water is turned off	Turn water on
	Aerator or flow regulator is blocked by debris	Remove aerator and/or flow regulator from tap and remove debris. Install an inline strainer.
Handle is loose	Screw has come loose	Tighten handle screw
Flange does not screw down onto basin/sink surface	Tap bodies are set too far out	Re-position tap bodies and breach piece

SERVICE AND MAINTENANCE

1. Turn off the water supply and turn on the tap handle to drain water from the bodies.
2. Remove the temperature indicator from the handle.
3. Remove the handle from the tap.
4. Unscrew the ceramic head part from the body.
5. Check the o-ring on the ceramic head part for wear and damage. Replace if required.
6. Clean the head part and the body of any debris.
7. Replace the cartridge and hand tighten back into the body.
8. Follow the product installation guidelines for the relevant product to re-assemble.

WARRANTY

The warranty set forth herein is given expressly and is the only warranty given by the Galvin Engineering Pty Ltd. With respect to the product, Galvin Engineering Pty Ltd makes no other warranties, express or implied. Galvin Engineering Pty. Ltd. hereby specifically disclaims all other warranties, express or implied, including but not limited to the implied warranties of merchantability and fitness for a particular purpose.

Galvin Engineering Pty Ltd products are covered under our manufacturer's warranty available for download from www.galvinengineering.com.au Galvin Engineering Pty Ltd expressly warrants that the product is free from operational defects in workmanship and materials for the warranty period as shown on the schedule in the manufacturer's warranty. During the warranty period, Galvin Engineering will replace or repair any defective products manufactured by Galvin Engineering without charge, so long as the terms of the Manufacturer's warranty are complied with.

The remedy described in the first paragraph of this warranty shall constitute the sole and exclusive remedy for breach of warranty, and Galvin Engineering Pty Ltd shall not be responsible for any incidental, special or consequential damages, including without limitation, lost profits or the cost of repairing or replacing other property which is damaged if this product does not work properly, other costs resulting from labour charges, delays, vandalism, negligence, fouling caused by foreign material, damage from adverse water conditions, chemical, electrical or any other circumstances over which Galvin Engineering has no control. This warranty shall be invalidated by any abuse, misuse, misapplication, improper installation or improper maintenance or alteration of the product.

Within Australia: 1300 514 074 Outside Australia: P: +61 (0)8 9338 2344

F: +61 (0)8 9338 2340

sales@galvinengineering.com.au

www.galvinengineering.com.au

ABN: 78 008 719 382

PERTH | SYDNEY | MELBOURNE | BRISBANE | ADELAIDE

